



e-scope®

green efficiency

Impressions	03
Product characteristics	04
Technology	06
Functional description	07
Products	
e-scope® Otoscopes	08
e-scope® Ophthalmoscopes	09
Sets	10
Spares & accessories	11



green efficiency

e-scope®

OVERVIEW

e-scope®

IMPRESSIONS



POCKET INSTRUMENTS 2.0 WHITE LIGHT, GREEN TECHNOLOGY

3.7V LED illumination and conventional alkaline batteries – an almost impossible combination up to now. Not just pie in the sky, but state of the art. The new **e-scope®** is the perfect blend of leading-edge LED technology, more efficient diagnosis and an environment-friendly energy source. Because the **e-scope®** breaks new ground with its world innovation, the IPC (Integrated Power Converter): younger, smarter and greener.

The innovative potential of the **e-scope®**

- LED technology for otoscopes and ophthalmoscopes with low-reflection, bright and white light. The pure white light (approx. 5,500 K) ensures colour-neutral illumination in addition to improved colour differentiation, thereby aiding more efficient diagnosis in comparison with halogen or xenon bulbs.

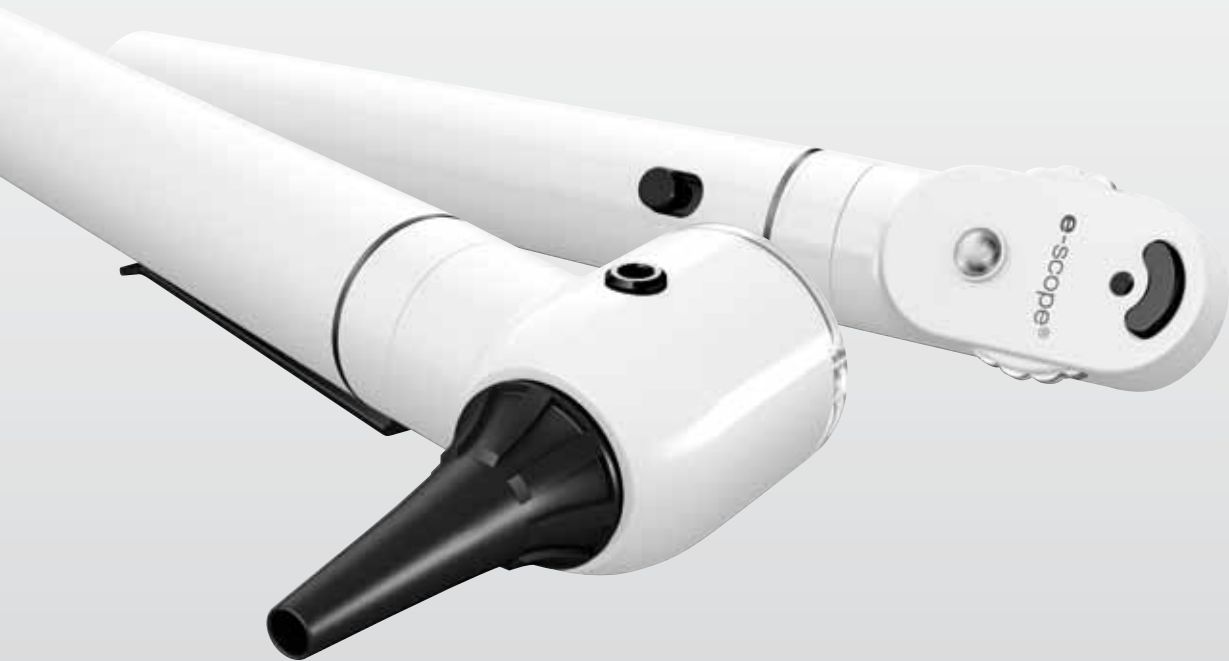

e-scope®

PRODUCT CHARACTERISTICS

CENTREPIECES OF THE **e-scope®** PIONEERING ADVANTAGES



LED illumination

For uniform illumination of the examination field with pure white light (5500 K). The LED illumination shows colours as they really are. Helpful for efficient diagnostics plus an almost unlimited service life.

Bulb service lives

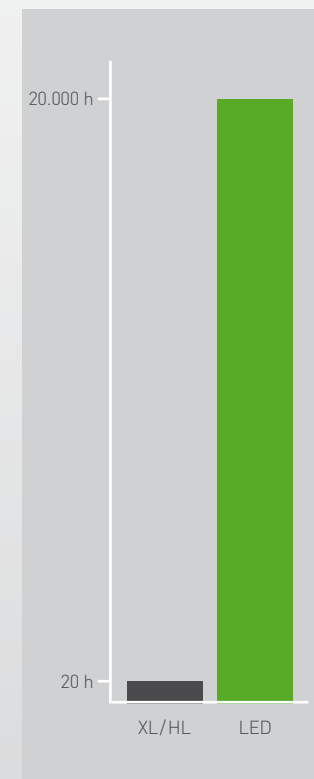

green efficiency

- Low maintenance costs thanks to long LED and battery service lives. Whilst the service life of a xenon light source is only approx. 20 hours, LED burns for at least 20,000 hours, i.e. over 2 years at a go – with **e-scope®**, even with two conventional AA batteries.
- Particularly high environment-friendliness, for the newly developed IPC in the **e-scope®** always converts the voltage of simple alkaline batteries into the optimum voltage required for LED operation, resulting in battery lives of around 50 operating hours.

Its optimum values in all these fields make the **e-scope®** a pioneering pocket instrument for flexible diagnosis.

Battery service lives

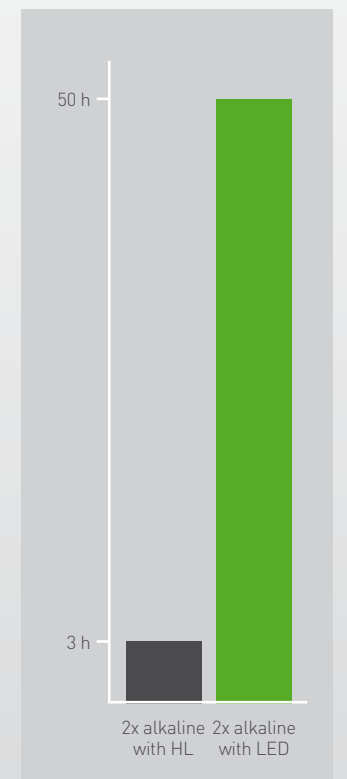

e-scope®

PRODUCT CHARACTERISTICS

THE WORLD FIRST IN THE **e-scope®**
2 CM² OF SHEER INNOVATION

AA batteries deliver a maximum 3V. However, a 3.7V voltage means that considerably more efficient LEDs can be used. Incompatible technical prerequisites? Not anymore. With the IPC, Riester has succeeded in producing a development that revolutionises illumination of pocket instruments. Because the tiny IPC inside the **e-scope®** always converts the voltage of conventional AA-size batteries into the optimum voltage supply for LEDs, thereby allowing efficient operation of LED illumination with alkaline batteries. As a result, the IPC not only allows optimum light quality, but also provides economic and ecological benefits. The service life of a light-emitting diode is therefore up to 1,000 times longer than that of xenon illumination and the batteries used in the **e-scope®** are discharged considerably more thoroughly thanks to the IPC; consequently, they do not need to be disposed of and replaced as often.



e-scope®
SIMPLY MORE INTELLIGENT

Continuous improvement has always been Riester's claim. With the new **e-scope®**, a further step has been successfully taken towards optimum illumination, environment-friendliness and profitability.



e-scope® PRODUCT RANGE



e-scope® otoscopes are available with halogen or vacuum direct illumination, F.O. xenon or F.O. LED

- Sealing precision optics pivotable to both sides with triple magnification for optimum view
- Sturdy ear speculum receptacle in hardwearing hygienic metal for e-scope®/ri-scope® L1/L2 speculum
- Compatible with ear speculae from other renowned manufacturers
- Suitable for performance of pneumatic tests (supplied without connector and insufflator)
- Available in a choice of black or white finish

e-scope® otoscope with fibre optics (F.O.)

- Economically priced fibre optic version with 2.5V xenon (3200 K) or innovative 3.7 V LED illumination (5500 K)
- Fibre optics for optimum focusing and guiding of the light

e-scope® otoscope with direct illumination

- Inexpensive basic model with low-reflection direct illumination with a 2.7V vacuum bulb (2500 K) or halogen illumination (3000 K)

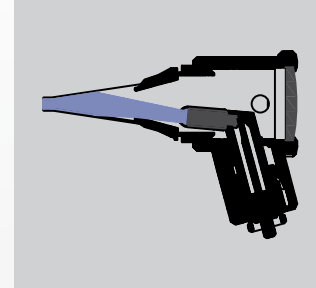

e-scope® otoscope with direct illumination

Minimised-reflection, economically priced direct illumination with 2.5V halogen or 2.7V vacuum illumination

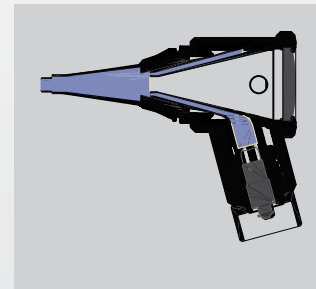

e-scope® otoscope F.O.

Fibre optics with 2.5V xenon or 3.7 V LED illumination ensure an unimpeded, free view

Kelvin data for otoscopes and ophthalmoscopes

LED	Xenon	Halogen	Vacuum
5500 K	3200 K	3000 K	2500 K

e-scope®

OTOSCOPES

e-scope® PRODUCT RANGE



e-scope® ophthalmoscopes are available with vacuum, halogen or LED illumination.

- With 2.7V vacuum or halogen illumination and with innovative 3.7V LED illumination for higher-contrast and more efficient diagnosis
- Dioptre disc with 18 corrective lenses (+/- 1, 2, 3, 4, 6, 8, 10, 15, 20 dioptres)
- Easy-to-use aperture wheel with six different apertures (fixation star, large circle, small circle, red free filter, blue filter, semi circle)
- High performance optics with aspherical condenser lens
- Spectacle protection
- Parallel optical path
- Dust-protected

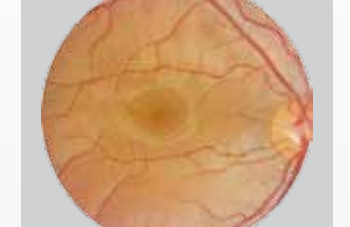

Healthy fundus

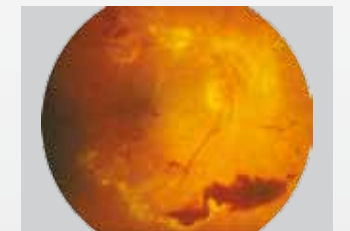

Pathological fundus

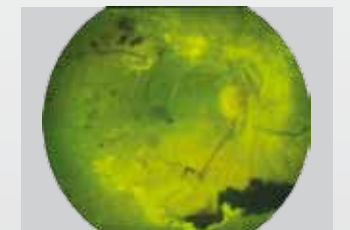

Fundus with red free filter

Optical path

Corneal and iris reflexes are avoided by separation of the parallel observation and illumination beams (Gullstrand's principle). The illuminated retinal area is fully visible – even with narrow pupils. Optimum conditions are achieved for ophthalmological examinations.

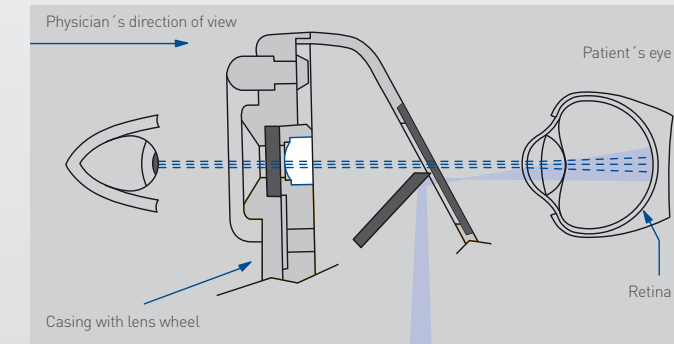

Dioptre disc

With 18 corrective lenses

D+ 1 | 2 | 3 | 4 | 6 | 8 | 10 | 15 | 20
D- 1 | 2 | 3 | 4 | 6 | 8 | 10 | 15 | 20

Apertures

With easy-to-use aperture wheel

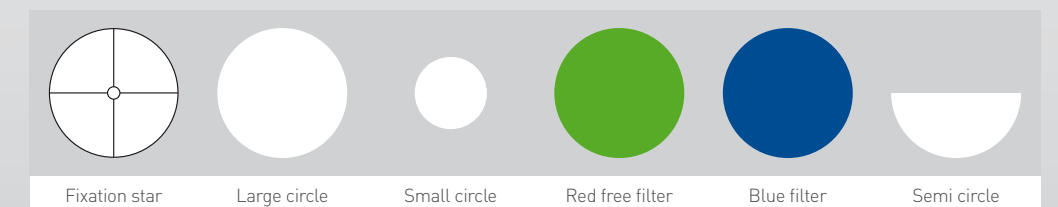

e-scope®

OPHTHALMOSCOPES

ALWAYS ON HAND: POCKET-SIZE SETS
SMALL SETS FOR A HIGH LEVEL OF SAFETY

e-scope® otoscopes and ophthalmoscopes are available in an impact-resistant case or in a space-saving bag. They include special inserts in which the instruments can be perfectly stowed and offer adequate space for the battery handle and ear speculums.



e-scope® otoscope with direct illumination

- Vacuum 2.7V, in bag white Art. No.: 2100-200
 black Art. No.: 2101-200
- HL 2.5V, in bag white Art. No.: 2100-201
 black Art. No.: 2101-201

e-scope® F.O. otoscope

- XL 2.5V, in case white Art. No.: 2110-202
 black Art. No.: 2111-202
- LED 3.7V, in case white Art. No.: 2110-203
 black Art. No.: 2111-203

e-scope® ophthalmoscope

- Vacuum 2.7V, in bag white Art. No.: 2120-200
 black Art. No.: 2121-200
- HL 2.5V, in case white Art. No.: 2122-201
 black Art. No.: 2123-201
- LED 3.7V, in case white Art. No.: 2122-203
 black Art. No.: 2123-203

e-scope® otoscope with direct illumination / ophthalmoscope

- Vacuum 2.7V, in bag white Art. No.: 2130-200
 black Art. No.: 2131-200

e-scope® F.O. otoscope / ophthalmoscope

- XL 2.5V, in case white Art. No.: 2130-202
 black Art. No.: 2131-202
- LED 3.7V, in case white Art. No.: 2130-203
 black Art. No.: 2131-203

SIMPLE HANDLING
SPARES AND ACCESSORIES FOR e-scope®



Reusable ear speculums

- 2mm 10 items Art. No.: 10775
- 2.5mm 10 items Art. No.: 10779
- 3mm 10 items Art. No.: 10783
- 4mm 10 items Art. No.: 10789
- 5mm 10 items Art. No.: 10795

Disposable ear speculums

- 2mm 100 items Art. No.: 14061-532
500 items Art. No.: 14062-532
1000 items Art. No.: 14063-532
- 2.5mm 100 items Art. No.: 14061-531
500 items Art. No.: 14062-531
1000 items Art. No.: 14063-531
- 3mm 100 items Art. No.: 14061-533
500 items Art. No.: 14062-533
1000 items Art. No.: 14063-533
- 4mm 100 items Art. No.: 14061-534
500 items Art. No.: 14062-534
1000 items Art. No.: 14063-534
- 5mm 100 items Art. No.: 14061-535
500 items Art. No.: 14062-535
1000 items Art. No.: 14063-535

Pneumatic test accessories

- Insufflator Art. No.: 10960
- Metal connector for the pneumatic test Art. No.: 10961

Replacement bulbs

- **for e-scope® F.O. otoscope**
XL 2.5V, pack containing 6 items Art. No.: 10600
LED 3.7V Art. No.: 14041
- **for e-scope® otoscope with direct illumination**
Vacuum 2.7V, pack containing 6 items Art. No.: 10488
HL 2.5V, pack containing 6 items Art. No.: 10489
- **for e-scope® ophthalmoscope**
Vacuum 2.7V, pack containing 6 items Art. No.: 14050
HL 2.5V, pack containing 6 items Art. No.: 10605
LED 3.7V Art. No.: 14051

